

BRG

OUR PASSION

SOUND PROOF
CANOPIES
division



listen to the silence

SOUND PROOF
CANOPIES
division

APOLLO

THE BEST CHOICE



APOLLO dio della musica, di origine Greca e poi Romana, rappresenta il nostro nuovo cofano. Il Cofano Apollo trasforma la potenza del tuo gruppo elettrogeno in silenzio. BRG con il cofano Apollo vuole far rivivere una nuova esperienza di silenzio. Una soluzione bella, vantaggiosa, silenziosa e di alta qualità. Inoltre grazie alla gamma Big Apollo, la massima qualità è garantita, con una insonorizzazione che arriva fino a 65 - 68 DbA per gruppi elettrogeni con potenze fino a 660 Kva.



APOLLO the god of music, a Greek and then Roman divinity, represents our new canopy. The canopy Apollo transforms your power generator in silence. Thanks to the canopy Apollo BRG wants to bring to life a new experience of silence. A high quality beautiful, advantageous and silent solution. Thanks to the Big Apollo range, the highest quality is guaranteed, with a hush that comes up to 65 - 68 DbA for power generators with power up to 660 Kva.

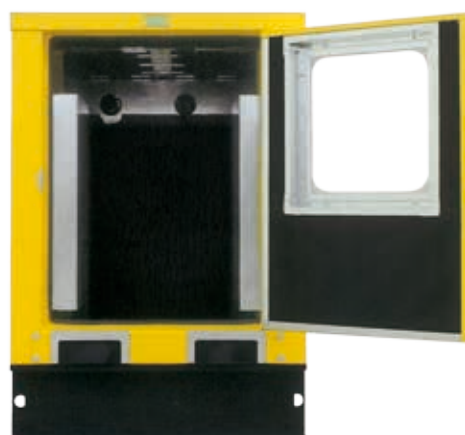
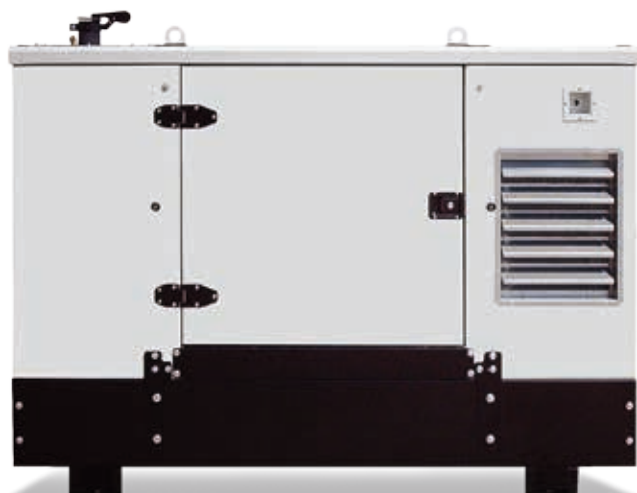

Il silenzio non è mai stato così divino BRG APOLLO
Silence has never been so divine BRG APOLLO



APOLLO

THE BEST CHOICE



BIG Apollo il cofano da 660 Kva

BIG Apollo the canopy for 660 Kva

CARATTERISTICHE APOLLO 	FEATURES OF APOLLO 
Struttura monoblocco in lamiera zincata microfiore brillante spessore 15/10	<i>Single structure in sheet metal galvanized microfiore brilliant thickness 15/10</i>
Insonorizzazione pari a 65 o 68 Dba ± 3 a 7 mt.	<i>Noise level: 65 or 68 Dba ± 3 to 7 mt.</i>
Coibentazione con materiale ignifugo in classe "O" lana minerale	<i>Insulating: by class "O" fire-proof material (rock wool)</i>
Montaggio semplice e veloce	<i>Simple and quick installation</i>
Guarnizioni di tipo automobilistico per garantire la massima tenuta acustica e agli agenti atmosferici	<i>Tubular seals of automotive type to ensure the maximum soundproof and the maximum resistance to any atmospheric agent</i>
Grande ispezionabilità ed elevata accessibilità interna mediante porte laterali e posteriori per la manutenzione e il controllo	<i>Large inspection room and easy access through side and back doors for maintenance and control</i>

Sollevamento mediante golfari	Easy lifting through ringbolts
Silenziatori di scarico:	Exhaust silencer:
<ul style="list-style-type: none"> • Marmitte residenziali posizionate all'interno (Dx oppure Sx) 	<ul style="list-style-type: none"> • <i>The silencer is placed inside the canopy (on the right or on the left)</i>
<ul style="list-style-type: none"> • Elevato abbattimento acustico pari a 28 - 30 Dba 	<ul style="list-style-type: none"> • <i>High noise abatement up to 28 - 30 Dba</i>
Aspirazione / espulsione aria:	Air intake / expulsion:
<ul style="list-style-type: none"> • Aspirazione mediante due griglie laterali anti pioggia 	<ul style="list-style-type: none"> • <i>Air intake through two lateral anti-rain grids</i>
<ul style="list-style-type: none"> • Espulsione mediante un setto opportunamente studiato 	<ul style="list-style-type: none"> • <i>Expulsion by a properly designed septum</i>
Verniciatura:	Painting:
<ul style="list-style-type: none"> • Fornitura standard RAL 7035 	<ul style="list-style-type: none"> • <i>Standard painting according to RAL 7035</i>
<ul style="list-style-type: none"> • Realizzata con l'applicazione di uno strato di fondo epossidico + uno di vernice poliuretana 	<ul style="list-style-type: none"> • <i>Painting made by an epoxidic bottom layer + polyuretan paint.</i>
Pannellatura e optional:	Panels & optional:
<ul style="list-style-type: none"> • Pannello posteriore per oblò 	<ul style="list-style-type: none"> • <i>Rear door panel for porthole</i>
<ul style="list-style-type: none"> • Possibilità di montare i quadri elettrici ad incasso 	<ul style="list-style-type: none"> • <i>Possibility to mount built-in electrical panels</i>

APOLLO

THE BEST CHOICE

Misure: Dimensions:

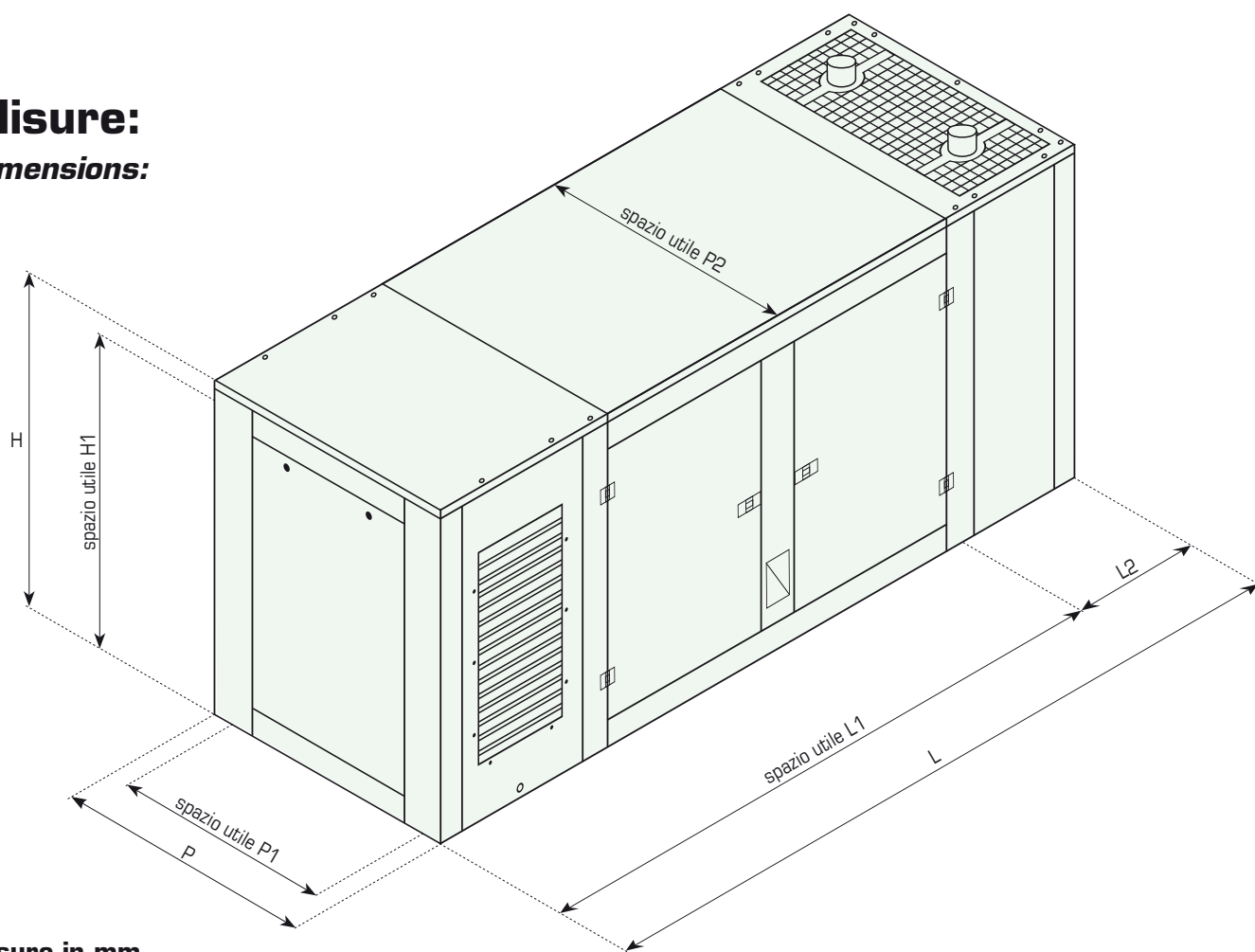

Misure in mm
Measures mm

Modello Model	Kva	Peso Weight	Lunghezza (L) Length (L)	L1	Distanza filo Rad. (L2) Distance wire Rad. (L2)	Larghezza (P) Width (P)	P1	P2	Altezza (H) Height (H)	H1
3055.N	20-30	320	2150	1540	525	955	515	810	1135	1070
3055.A	30-60	395	2470	1850	525	955	515	810	1135	1070
3155.N	60-150	410	3100	2345	680	1150	625	1005	1235	1170
3155.A	60-150	480	3500	2745	680	1150	625	1005	1235	1170
3205.N	150-220	580	3500	2720	705	1220	810	1075	1535	1470
3205.A	150-220	700	4000	3220	705	1220	810	1075	1535	1470
3355.N	200-330	1020	4250	3370	795	1505	815	1348	1650	1570
* 3555.N	400-600	1400	4450	3470	895	1650	1075	1490	1910	1835

* Singola o doppia marmitta
Single or double silencer

DAFNE

QUALITY AT THE RIGHT PRICE



Dafne, ninfa del bosco, figlia del fiume Peneo, la bellezza della semplicità. Questa è la nuova linea di cofani BRG, una linea pensata, studiando attentamente le esigenze dei nostri clienti. Una linea economica, ma di qualità.



Dafne, the wood nymph-daughter of the river Peneus, the beauty of simplicity. This is the new line of BRG canopies, a line designed by carefully studying the needs of our customers. An inexpensive line, whose quality guarantees nonetheless speed, moderate costs, refinement. Dafne, the simple, effective, fast, canopy.



Le caratteristiche fondamentali dei cofani DAFNE

Semplice

Efficace

Veloce

The key features of the DAFNE canopies:

Simple

Effective

Fast

DAFNE, il cofano semplice, efficace, veloce.
DAFNE is quality at the right price.

DAFNE

QUALITY AT THE RIGHT PRICE



CARATTERISTICHE DAFNE

Struttura monoblocco in lamiera zincata microfiore brillante spessore 10/10
Insonorizzazione pari a 68 Dba ± 3 a 7 mt.
Coibentazione con materiale ignifugo in classe "O" lana minerale
Inseriti di bloccaggio perfettamente centrati e prefissati per un montaggio senza problemi
Guarnizioni di tipo automobilistico per garantire la massima tenuta acustica e agli agenti atmosferici
Accessibilità interna mediante porte laterali e posteriori per la manutenzione e il controllo
Sollevamento mediante golfari opportunamente posizionati e dimensionati, passacavi laterali o posteriori



FEATURES OF DAFNE

<i>Single structure in sheet metal galvanized microfiore brilliant thickness 10/10</i>
<i>Noise level: 68 Dba ± 3 to 7 mt.</i>
<i>Insulating: by class "O" fire-proof material wool rock</i>
<i>Clamping inserts perfectly centred and pre-fixed for an easier assembly</i>
<i>Tubular seals of automotive type to ensure the maximum soundproof and the maximum resistance against any atmospheric agents</i>
<i>Large inspection room and easy access through side and back doors for maintenance and control</i>
<i>Lifting through properly set ringbolts, side or back chocks</i>

Silenziatori di scarico:

- Marmitte residenziali posizionate all'interno (Dx oppure Sx)
- Elevato abbattimento acustico pari a 26 - 28 Dba

Exhaust silencer:

- *The silencer is placed inside the canopy (on the right or on the left)*
- *High sound - laying up to 26 - 28 Dba*

Ventilazione:

- Aspirazione mediante una o due griglie laterali
- Espulsione mediante un setto opportunamente studiato

Front conveyor:

- *Air intake through one or two lateral grids*
- *Expulsion through properly designed septum*

Verniciatura:

- Fornitura standard RAL 7035
- Realizzata con l'applicazione di uno strato di fondo epossidico + uno di verniciatura poliuretana

Painting:

- *Standard painting according to RAL 7035*
- *Painting made by an epoxidic bottom layer + polyuretan paint.*

DAFNE

QUALITY AT THE RIGHT PRICE

Misure: Dimensions:

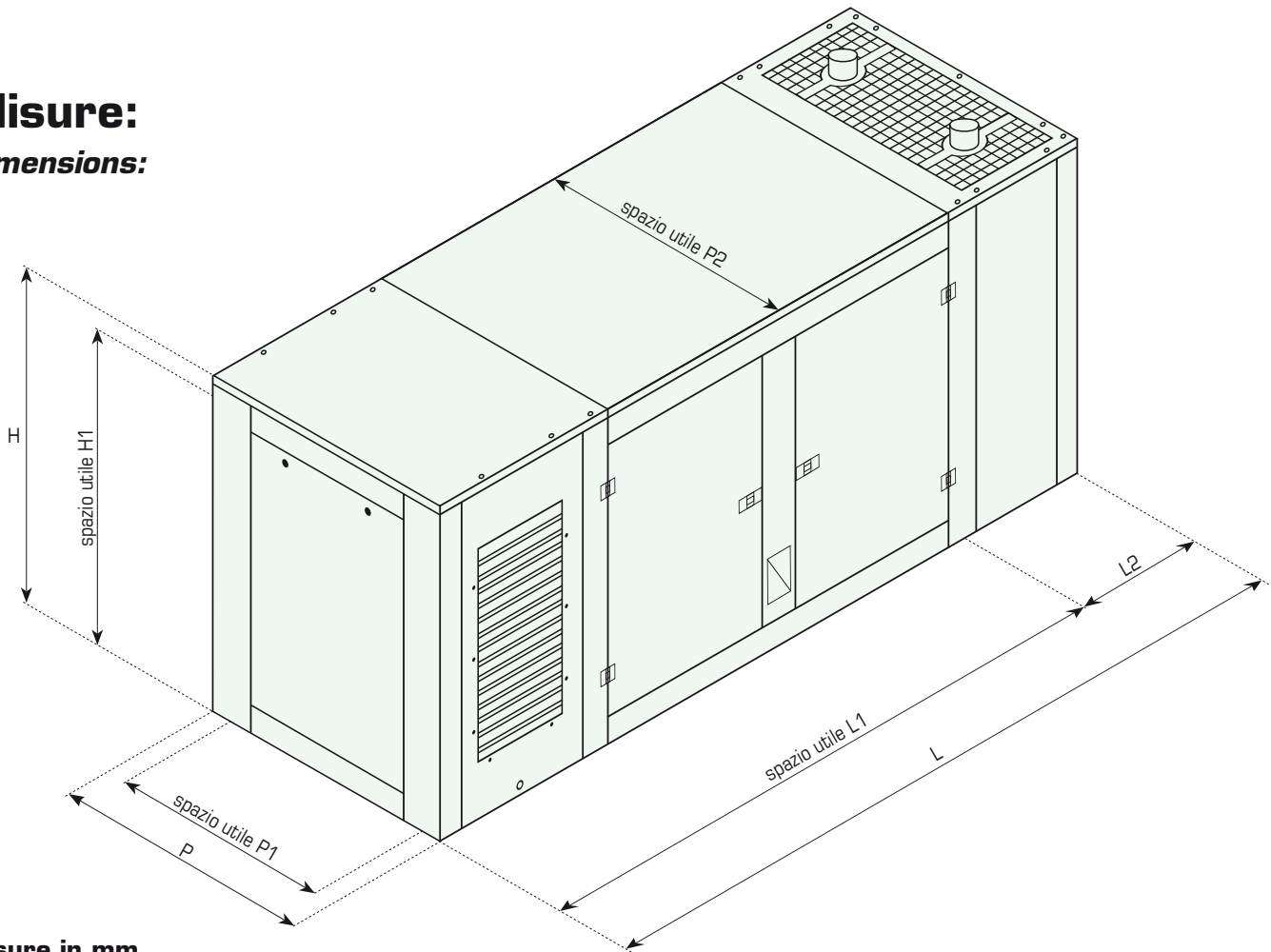

Misure in mm
Measures mm

Modello Model	Kva	Peso Weight	Lunghezza (L) Length (L)	L1	Distanza filo Rad. (L2) Distance wire Rad. (L2)	Larghezza (P) Width (P)	P1	P2	Altezza (H) Height (H)	H1
* 7500.N	0-20	100	1500	1110	342	750	598	650	870	830
* 7500.A	0-20	110	1640	1250	342	750	598	650	870	830
3020.N	0-20	160	1860	1485	330	770	618	675	840	800
7080.N	30-80	250	2250	1800	412	955	649	850	1100	1060
7140.N	80-140	380	3100	2635	412	1100	694	1004	1420	1370
7230.N	140-230	550	3500	2888	562	1170	764	1078	1570	1520

* Altre cofanature non standard su richiesta
Non standard canopies on request

ERCOLE

THE FORCE OF ADAPTION



La base BRG ERCOLE è forte, è forte nell'adattamento ai diversi tipi di motori, è forte nella qualità, è forte nel risparmio di tempi e costi. Le colonne d'Ercole, il limite della conoscenza, grazie alla base BRG ERCOLE vengono superate, con un prodotto imbattibile nella qualità e nella velocità di adattamento e montaggio.

"Con gli uomini antichi, no, non vorrei mai misurarmi, non certo con Eracle (ERCOLE), Eurito Ecalieo..."
(Odissea)

ERCOLE è una base adattabile ed economica. Con ERCOLE risparmi tempo e con grande facilità la puoi adattare a molte tipologie di G.E. ERCOLE è fornibile in Kit (su richiesta). Con ERCOLE si risparmia tempo e si hanno minori preoccupazioni. ERCOLE è la migliore risposta alle esigenze dei nostri clienti, una qualità imbattibile grazie alla ricerca Ingegneristica da cui nasce e grazie alle nostre macchine automatiche.



ERCOLE è: la migliore innovazione per le migliori imprese
ERCOLE is: the best innovation for the best businesses

ERCOLE



THE FORCE OF ADAPTION



ERCOLE is strong, it is strong in adapting to different types of engines, it is strong in quality and in saving time and costs. The Pillars of Hercules, the limit of knowledge, are overcome thanks to the BRG ERCOLE Base, with a product which is unbeatable in quality and speed of adjustment and assembly.



*"Yet with men of former days I will not seek to vie,
with Heracles or with Eurytus of Oechalia...."
(Homer, Odyssey)*

ERCOLE is adaptable and cost-effective. With ERCOLE you can save time and you can adapt it easily to many types of GE. ERCOLE is available in kit (upon request of BRG PACK). You can save time and concern with ERCOLE. ERCOLE is the best response to the needs of our customers, an unbeatable quality which comes from the Engineering Research and our automatic machines.

CARATTERISTICHE ERCOLE 	FEATURES OF ERCOLE 
Economica e veloce nell'adattamento	<i>Cost-effective and fast in adaptability</i>
Su richiesta fornibile in kit (BRG pack)	<i>In kit on request (BRG pack)</i>
Accoppiamenti motore-base semplici e veloci	<i>Simple and fast coupling motor-base</i>
Semplice e adattabile a vari tipi di Genset	<i>Simple and adaptable to various types of Genset</i>
Bella, resistente e innovativa	<i>Beautiful, resistant and innovative</i>
Basata sulla ricerca ingegneristica	<i>Based on engineering design</i>
Imbattibile nella qualità (lavorata con macchine automatiche a controllo)	<i>The best of quality (manufactured by automatically controlled machines)</i>
La base adattabile, di qualità, robusta e comoda	<i>Adaptability & quality, strong and convenient</i>
Con Ercole risparmi tempo senza rinunciare al massimo della qualità	<i>With Ercole, you can save time without renouncing the top quality</i>

ERCOLE

THE FORCE OF ADAPTION

Basi complete di: 	Base plate with: 
2 traversi inclusi nel prezzo per motore e alternatore (1+1)	2 crosses included in the price for engine and alternator (1+1)
Verniciatura RAL 9005	Painting RAL 9005
Piedi di appoggio singoli imbullonati	Single bolted base
Piastre attacco cofanatura	Plates for canopy connection
Lamiera contenimento perdite	Metal sheet to reduce losses

Misure: / Dimensions:				
Modello / Model	Peso Weight (Kg)		Misure / Measures (mm) Larghezza x Lunghezza x Altezza (Width x Length x Height)	Codice Code
ABN055	120	N	955 X 2150 X 300	250-ABN055N-032
	130	A	955 X 2470 X 300	250-ABN055A-032
ABN155	192	N	1150 X 3100 X 300	250-ABN155N-032
	215	A	1150 X 3500 X 300	250-ABN155A-032
ABN205	230	N	1220 X 3500 X 300	250-ABN205N-032
	245	A	1220 X 4000 X 300	250-ABN205A-032
ABN75.N	85	for DAFNE	750 X 1500 X 250	250-ABN075.N-001
ABN75.A	100	-	750 X 1640 X 250	250-ABN075.A-001
ABN020.N	115	-	770 X 1860 X 250	250-ABN020.N-001
ABN080.N	125	-	955 X 2250 X 300	250-ABN080.N-001
ABN140.N	180	-	1100 X 3100 X 300	250-ABN140.N-001
ABN230.N	220	-	1170 X 3500 X 300	250-ABN230.N-001
AB355.N	430	Welded	1505 X 3540 X 350	250-AB355.N-001
AB555.N	490	Welded	1650 X 3650 X 350	250-AB555.N-001



Risparmi nel trasporto	Meno spazio / Meno costi Risparmi fino al 50% dei costi
Risparmi nel costo	Cabina + base ad un prezzo vantaggioso
Aumenti la semplicità	In un solo pack trovi tutto il necessario, già pronto all'uso
Logistica di montaggio ottimizzata	Con semplici gesti, il montaggio è completato
Disponibile in 2 versioni	APOLLO + ERCOLE DAFNE + ERCOLE

Savings in transport	<i>Less space / Fewer costs You can save up to 50% of shipping costs</i>
Savings in costs	<i>canopy + base = special price</i>
Increase easiness	<i>One pack, great easiness, ready to be used</i>
Optimized assembly logistics	<i>Simplified assembly</i>
Available in 2 versions	APOLLO + ERCOLE DAFNE + ERCOLE

BRG PACK

APOLLO + ERCOLE	Kva	Peso / Weight (Kg) Base + Cofano <i>Base + Canopy</i>	Misure / Measures (mm) Lunghezza x Larghezza x Altezza <i>(Length x Width x Height)</i>
3055.N + ABN055.N	20 - 30	440	2250 x 1000 x 700
3055.A + ABN055.A	30 - 60	525	2550 x 1000 x 700
3155.N + ABN155.N	60 - 150	602	3200 x 1200 x 800
3155.A + ABN155.A	60 - 150	695	3600 x 1200 x 800
3205.N + ABN205.N	150 - 200	810	3600 x 1250 x 900
3205.A + ABN205.A	150 - 200	945	4100 x 1250 x 900
* 3355.N + AB355.N	200 - 330	1430	3540 x 1505 x 1100
* 3555.N + AB555.N	330 - 660	1890	3650 x 1650 x 1100

* La dimensione della altezza potrebbe subire variazioni / *The height dimension of the pack could be different*





DAFNE + ERCOLE	Kva	Peso / Weight (Kg) Base + Cofano <i>Base + Canopy</i>	Misure / Measures (mm) Lunghezza x Larghezza x Altezza <i>(Length x Width x Height)</i>
7500.N + ABN750.N	13 - 20	185	1500 x 750 x 600
7510.N + ABN750.N	13 - 20	210	1500 x 750 x 600
3020.N + ABN020.N	20	275	1900 x 800 x 600
7080.N + ABN080.N	20 - 80	450	2350 x 970 x 800
7140.N + ABN140.N	80 - 140	590	3200 x 1150 x 800
7230.N + ABN230.N	140 - 230	780	3600 x 1200 x 900

SERIE AC

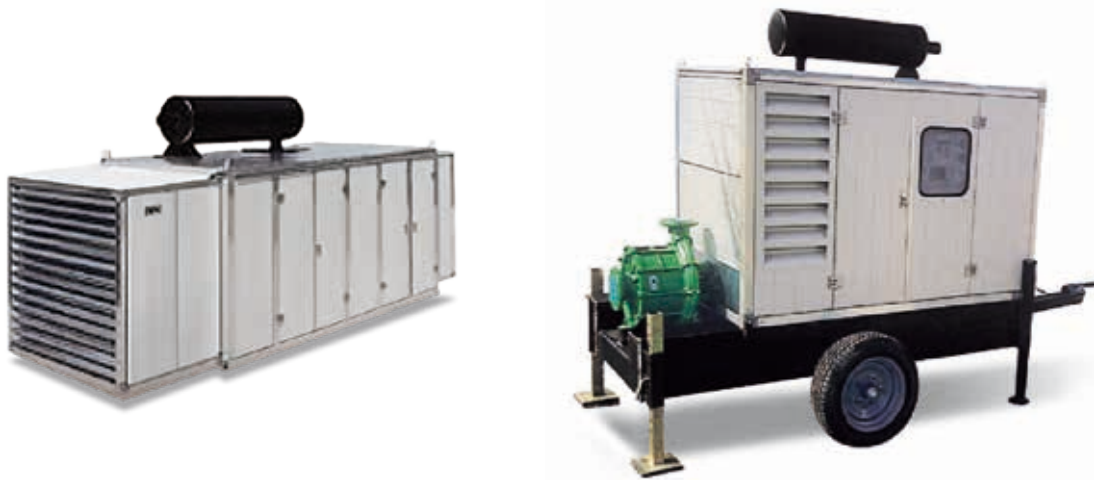
Cofanature insonorizzate per gruppi elettrogeni e motopompe Soundproof canopies for generator sets and motor pumps





CARATTERISTICHE SERIE AC 	FEATURES OF SERIE AC 
<p>Struttura in acciaio verniciato o in alluminio. Con pannellature di spessore 50 mm in lamiera zincata 10/10 Microfiore Brillante.</p>	<p>Structure in painted steel or aluminum. With panels 50 mm in thick sheet zinc-coated 10/10 Microfiore Brillante.</p>
<p>Insonorizzazione pari a: 70 - 65 - 60 Dba ± 3 a 7 mt</p>	<p>Noise level: 70 - 65 - 60 Dba ± 3 to 7 mt</p>
<p>Coibentazione con materiale insonorizzante in "classe O" Lana minerale</p>	<p>Insulation through soundproof material "class O" Wool Rock</p>
<p>Aspirazione / Espulsione aria:</p>	<p>Air intake / expulsion:</p>
<ul style="list-style-type: none"> • Aspirazione mediante griglie laterali anti-pioggia o tramite setto insonorizzato 	<ul style="list-style-type: none"> • Intake by side anti-rain grids or soundproofed septum
<ul style="list-style-type: none"> • Espulsione mediante un setto con uscita verticale o frontale 	<ul style="list-style-type: none"> • Expulsion through a septum with a vertical or front outlet
<p>Verniciatura standard RAL 7035</p>	<p>Standard painting RAL 7035</p>
<p>Silenziatore di scarico (interno o esterno) abbattimento rumore: 28 - 30 Dba</p>	<p>Exhaust silencer (internal or external) noise abatement: 28 - 30 Dba</p>
<p>Optional: pannello posteriore con oblò, porte in aggiunta, base portante, possibilità di averlo in kit (smontato).</p>	<p>Optional: Rear Panel with portholes, added doors, in addition, base carrier, the possibility of a kit supply (unassembled canopy).</p>

SERIE 1

Cofanature insonorizzate per gruppi elettrogeni e motopompe con motori raffreddati ad aria.

Air cooling and water cooling soundproofed canopies for generating sets and motor pumps.



CARATTERISTICHE SERIE AC 	FEATURES OF SERIE AC 
Struttura autoportante per il sollevamento del g.e. completo con gancio per il sollevamento	<i>Load-bearing frame in order to lift the complete generator set equipped with lifting hook</i>
Insonorizzazione pari a 70 Dba ± 3 a 7 mt (95 lwa)	<i>Soundproof: 70 Dba + 3 to 7 mt (95 lwa)</i>
Cofanature in lamiera rivestite di materiale insonorizzante in "classe 1" ignifugo con pellicola nera impermeabile	<i>Plate canopy covered with soundproof material "class 1" which is fireproof with black waterproof film</i>
Elettroventola estrazione aria vano motore	Air extraction from engine compartment is permitted by an electro fan
Verniciatura standard ral 7035 per la cofanatura e RAL 9005 per il basamento	Standard painting Ral 7035 for the canopy and RAL 9005 for the base
Apertura pneumatica del guscio superiore che permette una facile ispezionabilità e manutenzione del gruppo elettrogeno	<i>Pneumatic opening of the top allowing easy inspection and upkeeping of the generator set</i>
Gamma dei prodotti fino a kva 16.5 con raffreddamento motore ad aria, diesel/benzina	<i>Product range until kva 16,5 with air or water cooling of the diesel/fuel engine</i>
Predisposizione, su richiesta, uscita prese elettriche e alloggiamento per quadro elettrico posteriore/laterale	<i>On request prearrangement for the exit of the electrical cables and housing for back/side electrical board</i>



OFFICINE BRG srl
Via Delle Ville 165/A
42016 S.Girolamo di Guastalla (RE)
tel. +39-0522.820241 - fax. +39-0522.820293
brg@officinebrg.com



UNI EN ISO
9001:2008

www.officinebrg.com